





-  Sollevatore elettroidraulico a due colonne
-  Electro-hydraulic two post lift
-  Elektro-hydraulische Zweisäulenhebebühne
-  Elévateur électro-hydraulique à deux colonnes
-  Elevador electro-idraulico a dos columnas



Arresto bracci a inserimento automatico e sgancio automatico a terra

Automatic locking & unlocking of arms during on floor

Schwenkarmarretierung rastet automatisch ein (in der unteren Nullstellung) und aus (beim Heben aus der Nullstellung)

Arrêt des bras à insertion automatique et désinsertion automatique à terre

Parada de brazos de activación automática y desenganche automático de tierra



- Sollevatore simmetrico senza base, permette la massima comodità nella zona di lavoro • Due cilindri di sollevamento che non richiedono alcuna manutenzione. I cavi non portanti garantiscono la perfetta sincronizzazione dei carrelli indipendentemente dalla ripartizione del carico • Modello equipaggiato con 4 bracci lunghi a tre stadi: ideali per il sollevamento di furgoni e furgonati a passo lungo, consentono allo stesso tempo caricabilità ottimale anche per le autovetture • Valvole di sicurezza nei confronti di sovraccarichi e rottura di tubi idraulici • Valvola di controllo della velocità di discesa • Funzionamento: elettroidraulico
- Symmetric lift without baseframe for greater space free area at work • Equipped with two lifting rams which do not require maintenance. Non-bearing cables for perfect synchronisation of the trolleys no matter what distribution weight is loaded • Designed with 4 extended three-stage arms: ideal for lifting vans and long wheel based vehicles, whilst perfect for standard vehicles • Overload valve and safety valve in case of hydraulic hose failures • Slow descent controlled by means of hydraulic valve • Operation: electro-hydraulic
- Die grundrahmenfreie, symmetrische Hebebühne gewährleistet eine bedienerfreundliche Handhabung im Arbeitsbereich • Wartungsfreie Hubzylinder • Die Gleichlaufkabel gewährleisten den einwandfreien Gleichauf der Hubschlitten, unabhängig der Lastverteilung • Dieses Modell ist ausgerüstet mit 4 langen dreifach teleskopischen Armen, deshalb ist es ideal für das Heben von Lieferwagen und Kastenwagen mit langem Radstand und gleichermassen von PKW • Ein Überdruckventil und eine Rohrbruchsicherung runden die Sicherheitsausstattung der Hebebühne ab • Funktionsweise: elektrohydraulisch
- Elévateur symétrique sans base pour le meilleur confort dans la zone de travail • Les deux vérins de levage ne nécessitent d'aucun entretien. Les câbles portants assurent la parfaite synchronisation des chariots quelque que soit la distribution du poids • Ce modèle est équipé de 4 bras longs en trois parties: l'idéal pour le levage de fourgons et véhicules à long empattement, tout en garantissant une capacité de chargement optimale même pour les voitures • Clapet de surpression en cas de surcharge et rupture de tuyaux hydrauliques • Clapet de limitation vitesse de descente • Fonctionnement: électrohydraulique
- Elevador simétrico sin base, permite la máxima comodidad en la zona de trabajo • Dos cilindros de elevación que no requieren ningún mantenimiento, Los cables no portantes garantizan la perfecta sincronización de los carros independientemente de la repartición de la carga • Modelo equipado con 4 brazos largos de tres estadios: ideales para la elevación de camionetas y furgones de paso largo, permiten al mismo tiempo cargabilidad óptima también para los automóviles • Válvulas de seguridad de sobrecargas y rotura de tubos hidráulicos • Válvula de control de la velocidad de descenso • Funcionamiento: electro-hidráulico

Comando a uomo presente,
24V

Dead man controls,
24V

Totman-Schaltung,
24V

Commande "homme mort",
24V

Mandos de hombre presente,
24V

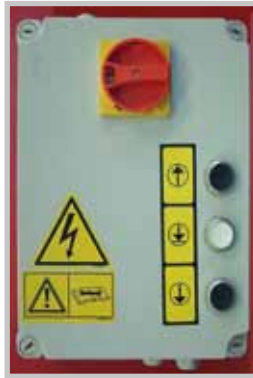

Dispositivo di appoggio meccanico ad inserimento automatico e disinserimento elettromagnetico a garanzia della massima sicurezza in fase di stazionamento

Mechanical support device with automatic activation and deactivation by means of electromagnetic valve insuring maximum safety during locking procedures

Mechanische Fallsicherung die automatisch ein- und austrastet, gewährleistet die normkonforme Sicherheit beim Absetzen in die mechanische Fallsicherung

Dispositif d'appui mécanique à insertion automatique et désinsertion électro-magnétique pour la mise en sécurité

Dispositivo de apoyo mecánico de activación automática y desactivación electromagnética como garantía de la máxima seguridad en fase de estacionamiento



Bracci predisposti per l'alloggiamento rapido di prolunghie

Arms suitable for quick drop-in extensions

Aufnahmen mit Schnellstecksystem erleichtern den Einsatz von Verlängerungen.

Bras prévus pour le montage rapide de rallonges

Brazos dispuestos para el alojamiento rápido de suplementos.



Opzioni



Optionals



Sonderzubehör



Options



Opcionales

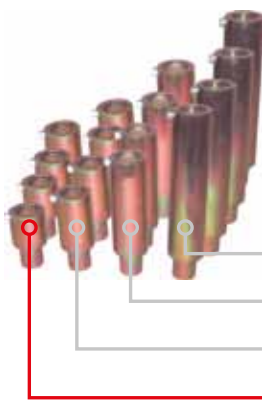

Estensioni per tamponi (kit 4 pz)

Lifting pad extensions (4 pcs set)

Hubspindelverlängerungen (Satz 4 Stk)

Rallonges pour tampons (jeu de 4 pcs)

Extensiones para tacos (kit 4 un.)

250 mm (L955)

170 mm (L954)

100 mm (L953)

60 mm (L956 standard included)

Esecuzione con motore monofase

Single-phase motor

Moteur monophasé

Ausführung mit Einphasenmotor

Motor monofásico

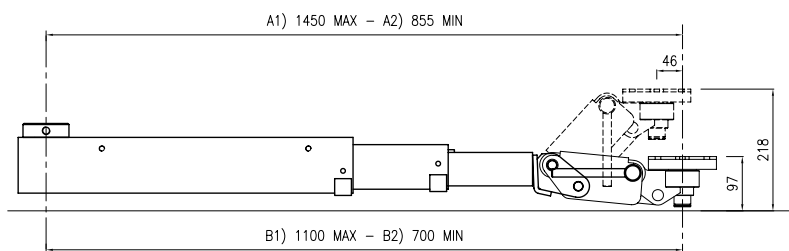
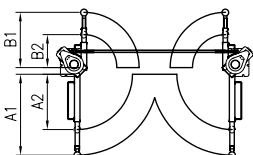

Tamponi click system

Click system pads

Tragtablet mit Click System

Tampons de levage click system

Tacos click system

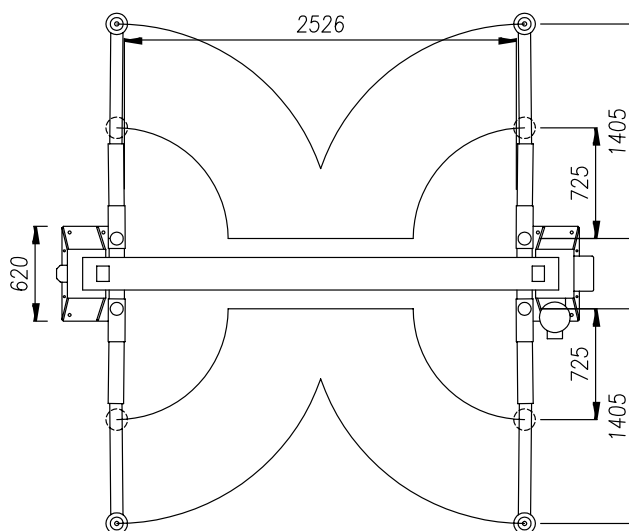
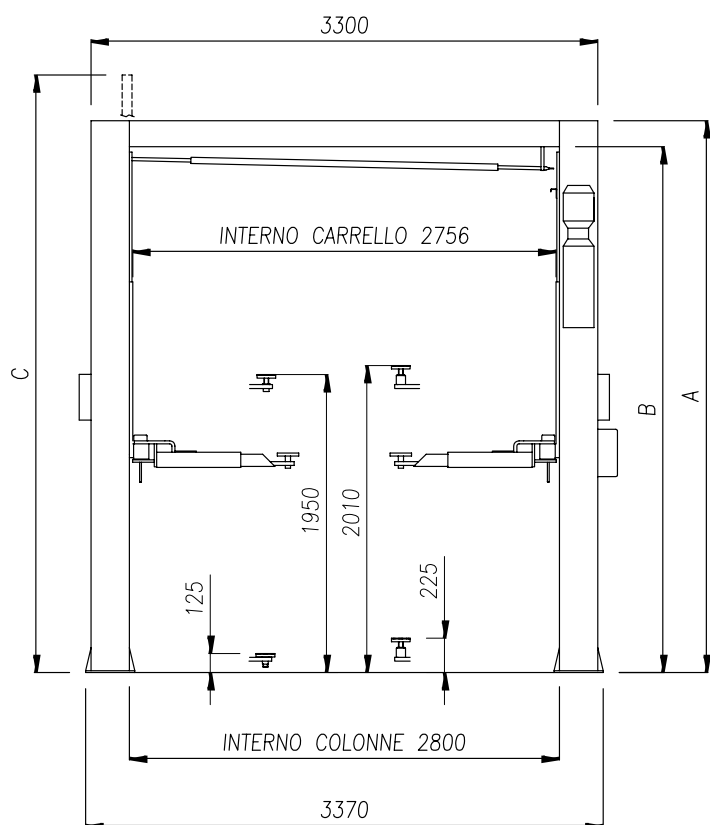

	Versione /	Version /	Version /	Version
	208I	208I.2	208I.3	208I.4
A	3600	4200	4500	5100
B	3430	4030	4330	4930
C	3900	3900	3900	3900



Dati tecnici	Technical data	Technische Eigenschaften	Caractéristiques techniques	Datos técnicos	
Portata	Capacity	Tragfähigkeit	Capacité	Capacidad	4.000 kg
Peso	Weight	Gewicht	Poids	Peso	850/950 kg
Salita/Discesa	Lifting/lowering	Hub/Senkzeit	Levage/descente	Subida/Bajada	35 s
Altezza di sollevamento	Lifting height	Hubhöhe	Hauteur de levage	Altura de elevación	1950 mm
Motore	Motor	Motorleistung	Puissance moteur	Motor	2,2 kW - 3 ph 230- 400V/50 Hz